



# Manholes



A0721 Monitoring Well Manholes	2-3	A0717 Standard Manholes, Round	8-9
A0717 Square Manholes & Vaults	4-6	A0716 Composite Manholes	10-11
A0727/A0728 Well Protectors	7		

## EMCO WHEATON RETAIL CORPORATION

2300 Industrial Park Dr. • Wilson, NC 27893 • 252-243-0150 • 252-243-4603 (fax) • [www.emcoretail.com](http://www.emcoretail.com)

# Monitoring Well Manholes

## A0721 Monitoring Well Manholes

All Emco Wheaton Monitoring Well Manholes incorporate cast-in identification triangles in accordance with API recommendations and meet AASHTO H20 wheel loading.

- Painted ductile iron lid and rim
- Optional galvanized steel or polyethylene skirt
- Bolt-down units have water-tight lids
- Custom skirt heights available
- Heavy Duty (16 gauge hot rolled carbon steel) skirts available. 100% welded skirt and seam. To order, replace the first digit of the variant number with a 2.



■ City of LA Approval BR800075  
A0721-001ID, A0721-008CEID  
A0721-101ID, A0721-108ID



Built-in side handle on 18" models - one hand opening and positioning



ID tag available on all models; large enough for all new regulatory requirements. To order, add "ID" to the end of the part number.

**A0726-050ID** ID Tag Kit  
Includes tags and rivets for 50 units

## A0720 Locking Cap & Collar

The Emco Wheaton A0720 locking cap and collar is used to limit access and seal monitoring wells and can be threaded or solvent welded onto a 4" PVC monitoring well pipe. It displays the monitoring well designation and includes a padlock. The cap and collar are both made of durable ABS plastic.

Model No.	Description	Pipe Size	Lbs.
A0720-001	Locking Cap and Collar	4"	1.3

### Replacement Parts

564029 Lock/Key Set A0720

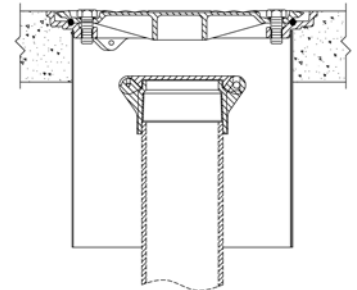

## A0721-112 12" Locking Monitoring Well Manhole

- Corrosion-free - all components are hard coat anodized aluminum
- Lockable, for added security
- Heavy-duty, reinforced lid with water-tight seal
- Meets AASHTO H20 wheel loading
- T-handle available, p/n A0081-112
- Weighs 25.7 lbs.

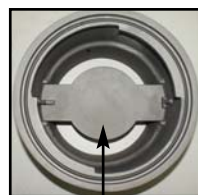

Locking Plate



# Monitoring Well Manholes

## A0721 Monitoring Well Manholes

Size	Model No.	Style	Skirt Type	Overall Height	Clear Hole ID	Max. Dia.	Lbs.
<b>5"</b>	* <b>A0721-105</b>	Bolt-down	Steel	8.5"	3.8"	6.0"	5.7
	A0721-006A	Bolt-down	Poly	7.5"	4.5"	6.7"	5.1
<b>6"</b>	* <b>A0721-106</b>	Bolt-down	Steel	7.5"	4.5"	6.7"	6.3
	* <b>A0721-106A</b>	Bolt-down	Steel	9.5"	4.5"	6.7"	6.5
<b>7"</b>	A0721-107	Bolt-down	Steel	12.2"	5.1"	8.9"	12.5
	* <b>A0721-008</b>	Bolt-down	Poly	12.3"	6.0"	9.9"	11.7
	A0721-008CE	BD, Large Bolts, White Lid	Poly	12.3"	6.0"	9.9"	11.1
	A0721-008LA	Lay-in	Poly	12.3"	7.8"	9.9"	10.4
<b>8"</b>	A0721-088	Bolt-down	Poly	8.0"	6.0"	9.9"	13.6
	* <b>A0721-108</b>	Bolt-down	Steel	12.7"	6.0"	9.9"	13.7
	* <b>A0721-188</b>	Bolt-down	Steel	9.2"	6.0"	9.9"	12.8
	* <b>A0721-188L</b>	Lay-in	Steel	8.9"	7.8"	9.9"	11.9
	A0721-208W****	Bolt-down, Welded w/Lugs	HD Steel***	12.5"	6.0"	9.9"	12.7
	A0721-308	BD, 3 Bolts, White Lid	Steel	8.8"	6.4"	9.4"	12.8
	A0721-308A	BD, 3 Bolts, White Lid	Steel	12.8"	6.4"	9.4"	13.7
	A0722-008**	Bolt-down	Poly	12.3"	6.0"	9.9"	12.4
	* <b>A0721-001</b>	Bolt-down	Poly	12.0"	9.4"	15.1"	23.0
	A0721-001CC	Bolt-down w/Rebar Tabs	Poly	12.0"	9.4"	15.1"	23.1
<b>12"</b>	A0721-001L	Lay-in	Poly	12.0"	11.2"	13.8"	22.8
	* <b>A0721-101</b>	Bolt-down	Steel	12.0"	9.4"	15.1"	28.8
	A0721-101A	Bolt-down	Steel	18.0"	9.4"	15.1"	31.0
	A0721-101L	Lay-in	Steel	12.0"	11.2"	13.8"	28.6
	A0721-119	Bolt-down	Steel	19.0"	9.4"	15.1"	36.3
	A0721-128	Bolt-down	Poly	8.1"	9.4"	15.1"	21.9
	A0721-128A	Bolt-down	Steel	8.0"	9.4"	15.1"	23.6
	A0721-201	Bolt-downHD	Steel***	12.0"	9.4"	15.1"	28.0
	A0722-001**	Bolt-down	Poly	12.0"	9.4"	15.1"	24.3
	<b>18"</b>	* <b>A0721-018</b>	Bolt-down	Steel	12.3"	13.8"	18.4"
A0721-118		Bolt-down	Steel	18.0"	13.8"	18.4"	69.5

\* Most common variant

\*\* Includes locking cap & collar

\*\*\* Heavy duty

\*\*\*\* Compliant with Wisconsin Administrative Code, Groundwater Monitoring Well Requirements, NRI41.13, Subsection 4b

### Lid Replacement Parts

Part No.	Lid	Description	Lbs.	Part No.	Lid	Description	Lbs.
569883	5"	Lid Ductile Bolt-down	3.0	566419	8"	O-ring for 3/8" Bolt	
569885	5"	Lid Gasket		566334	8"	O-ring for 5/8" Bolt	
494263	5"	Bolt, 3/8" x 0.5"		568715	8"	Neoprene Washer for 3/8" Bolt	
568692	6"	Lid Ductile Bolt-down	2.4	569723	12"	Lid Ductile Lay-in	11.6
568820	6"	Lid Gasket		563980	12"	Lid Ductile Bolt-down	11.0
568662	6"	Bolt, 5/16" x 0.75"		563593	12"	Lid Gasket	
571700	7"	Lid Ductile Bolt-down	3.3	494262	12"	Bolt & O-ring, 5/8" x 1.75"	
571702	7"	Lid Gasket		566334	12"	O-ring for 5/8" Bolt	
494261	8"	Bolt & Neoprene Washer, 3/8" x 1"		567712	18"	Lid Ductile Bolt-down	28.8
569285	8"	Lid Ductile Lay-in	5.1	567995	18"	Lid Gasket	
569106	8"	Lid Ductile Bolt-down	5.1	494262	18"	Bolt & O-ring, 5/8" x 1.75"	
567150	8"	Lid Ductile Bolt-down, A0721-008CE	5.1	494375	18"	Bolt & O-ring, 3/8" x 2"	
570767	8"	Lid Ductile Bolt-down, A0721-308 (3 bolt)	5.1	566419	18"	O-ring for 3/8" Bolt	
567146	8"	Lid Gasket		566334	18"	O-ring for 5/8" Bolt	
494260	8"	Bolt & O-ring, 5/8" x 1", A0721-008CE		568715	18"	Neoprene Washer for 3/8" Bolt	
494261	8"	Bolt & Neoprene Washer, 3/8" x 1"					

# Standard Manholes

## A0717 Square Manholes and Vaults



A0717-724VW



Lift Assist

A0717-736VWL

The Emco Wheaton A0717 square manhole provides ease of access to a variety of tank hardware and monitoring equipment.

### All Square Manholes

- 3/8" heavy duty diamond plate lid
- 16 gauge steel skirt
- Meets AASHTO H20 wheel loading

### Locking Vault Manholes

- Double hinged lid opens and folds back to 180°
- Lock-access lid permanently fastened with anti-theft chain; secured with single pinned bolt

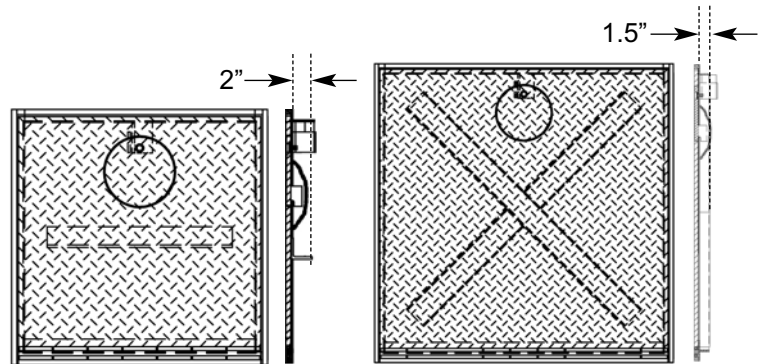

The 24" and 30" vaults are reinforced with 2"x2"x1/4" steel angle

The 36" and 48" vaults are reinforced with cross bracing of 3" structural steel channel

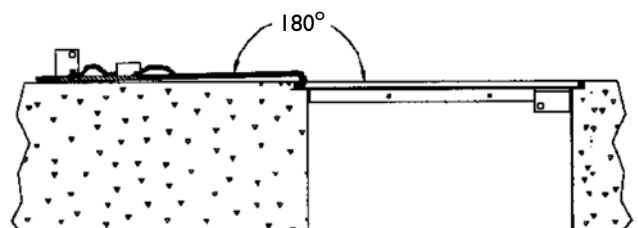

# Standard Manholes

## A0717 Square Manholes and Vaults

Size	Model No.	Style	Overall Height	Lid Lbs.	Total Lbs.
<b>12"</b>	* <b>A0717-712VW</b>	Locking Vault Water-resistant	11.6"	18	38.1
	A0717-712VWA	Locking Vault Water-resistant	24.6"	18	38.1
	A0717-712VWB	Locking Vault Water-resistant	18.6"	18	42.5
<b>18"</b>	A0717-718	Lay-in	9.6"	36	56.3
	* <b>A0717-718ABW</b>	Bolt-down Water-resistant	18.6"	36	73.3
	A0717-718BWA	Bolt-down Water-resistant	24.6"	36	87.3
	* <b>A0717-718VW</b>	Locking Vault Water-resistant	18.6"	36	76.8
	A0717-718VWA	Locking Vault Water-resistant	24.6"	36	96.0
	A0717-718VWL	Locking Vault Lift Assist Water-resistant	18.6"	36	77.3
<b>24"</b>	A0717-724	Lay-in	9.6"	65	88.4
	A0717-724A	Lay-in	24.6"	65	112.0
	A0717-724ABW	Bolt-down Water-resistant	24.6"	65	119.8
	A0717-724BBW	Bolt-down Water-resistant w/Handle	24.6"	65	122.2
	A0717-724BW	Bolt-down Water-resistant w/Handle	9.6"	65	107.2
	A0717-724E	Lay-in w/Handle	12.6"	65	117.0
	A0717-724V	Locking Vault	24.6"	65	116.5
	* <b>A0717-724VW</b>	Locking Vault Water-resistant	24.6"	65	121.5
	A0717-724VWB	Locking Vault Water-resistant	10.6"	65	116.5
	A0717-724VWC	Vault Bolt-down Water-resistant w/Handle	24.6"	65	126.4
	A0717-724VWE	Locking Vault Water-resistant	18.6"	65	117.0
	* <b>A0717-724VWL</b>	Locking Vault Lift Assist Water-resistant	24.6"	68	120.9
	A0717-724VWCL	Vault Lift Assist Bolt-down WR w/Handle	24.6"	68	131.0
<b>30"</b>	A0717-730VW	Locking Vault Water-resistant	24.6"	123	200.0
	A0717-730VWL	Locking Vault Lift Assist Water-resistant	24.6"	123	200.0
<b>36"</b>	A0717-736VW	Locking Vault Water-resistant	36.6"	165	307.4
	A0717-736VWA	Locking Vault Water-resistant 36x24x24	24.6"	165	265.0
	A0717-736VWAL	Locking Vault Lift Assist WR 36x24x24	24.6"	165	270.0
	A0717-736VWE	Locking Vault Water-resistant	24.6"	165	285.0
	A0717-736VWL	Locking Vault Lift Assist Water-resistant	36.6"	171	287.0
	A0717-736VWLA	Locking Vault Lift Assist Water-resistant	24.6"	171	268.5
<b>48"</b>	A0717-748VWL	Locking Vault Lift Assist Water-resistant	48.6"	165	270.0
	A0717-748VWLA	Locking Vault Lift Assist Water-resistant	24.6"	165	270.0
	A0717-748VWLF	Locking Vault Lift Assist WR 24x48x24	24.6"	171	273.0

\*Most common variant

Custom sizes available upon request

V = Hinged; B = Bolt-down; W = Water-resistant; L = Lift Assist Lid

# Standard Manholes

## A0717 Custom Manholes and Vaults

Emco will custom build manholes and vaults to your specifications. Contact our customer service department at 800-234-4394 or sales@emcoretail.com.



**A0717-748VWLCSS**  
Hydrant Box, Lift Assist  
48"x22"x14"  
Stainless Steel



**A0717-772VWLD**  
Locking Vault, Lift Assist  
72"x72"x48"  
Bolt-Down Water Resistant



**A0717-042ABHD**  
Heavy Duty Manhole  
42"x10"  
1/2" Steel Lid  
**100,000 lb. Load Rating**



# Well Protectors

## A0727 Well Protectors

- Raintight Cap - one piece die cast aluminum cap is powdered coated for corrosion resistance and painted with contrasting black triangle
- Riveted Construction - cap overlaps hinge pins, preventing vandalism
- Lockable
- Top Kit - complete cap assembly for bare tubing
- Optimized height - clears tallest well plug

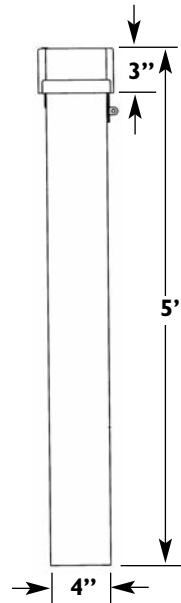

Model No.	Description	Material	Lbs.
A0727-004A	4"x4"x5' Square Well Protector	Aluminum	12.0
A0727-004S	4"x4"x5' Square Well Protector	Steel	23.0
A0727-004K	Top Kit for Bare Tubing	Aluminum	1.6
A0727-006A	6"x6"x5' Square Well Protector	Aluminum	21.8
A0727-008A	8"x8"x5' Square Well Protector	Aluminum	34.0
A0727-012A	12"x12"x40" Square Well Protector	Aluminum	25.0

Custom lengths available upon request

## A0728 Well Protectors

- Raintight Cap - welded steel construction cap overlaps pipe to prevent rain intrusion
- All Steel Construction
- Thick 14 gauge pipe
- Lockable
- Available in 4" & 6" diameters

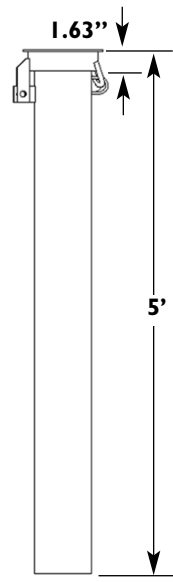

Model No.	Description	Material	Lbs.
A0728-004	4"x5' Round Well Protector	Steel	30.0
A0728-006	6"x5' Round Well Protector	Steel	39.9

Custom lengths available upon request

# Standard Manholes

## A0717 Round Manholes

The Emco Wheaton A0717 multi-purpose manhole provides access to all types of underground storage or containment vessels and meets AASHTO H20 wheel loading.

- Open throat design for easy access
- Optional galvanized steel or polyethylene skirt (8" & 12")
- Bolt-down units have water-resistant lids
- Cam-lock units have water-tight lids
- Built-in handle (18")
- Custom skirt heights available on all models

### 24" - 48" Models

- Diamond plate steel lid
- Hot rolled steel skirt
- Concrete anchors
- T-bar frame
- Recessed handle
- Available in lay-in, bolt-down and cam-lock versions



A0717-036B

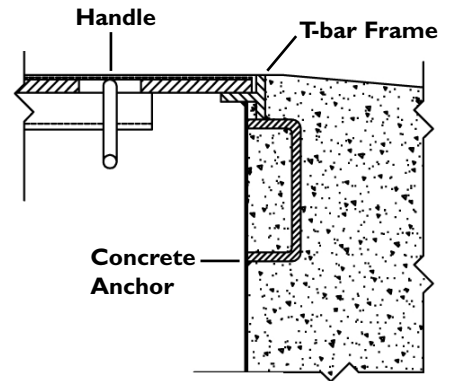

### Seal Options (24" - 48" Models)

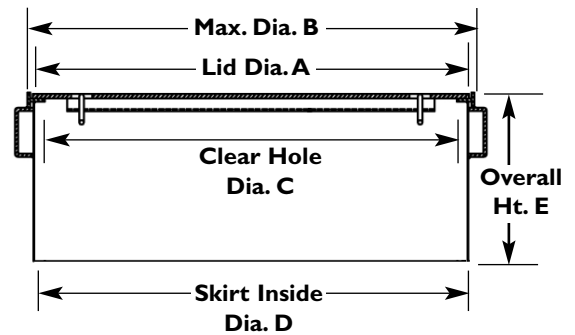
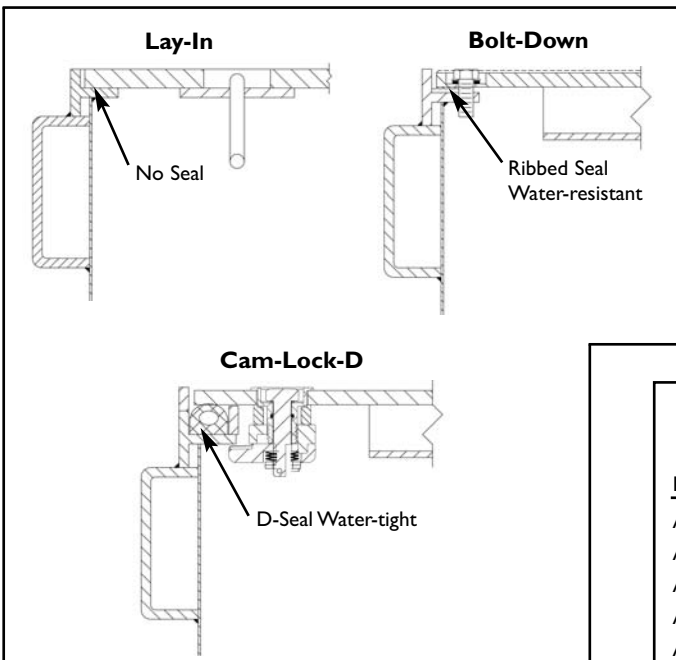

### 3/8" Steel Drop-In Replacement Lids For Competitors' Manholes

Emco	OPW	Franklin	Flexing	Morrison
A0717-039LID	E00618	781-448-06		
A0717-039M				318L-3812ACC
A0717-042LID			14U-4210C	
A0717-044LID	E00626	781-445-06		
A0717-044M				318L-4412ACC



# Standard Manholes

## A0717 Round Manholes

	Model Number	Style	Skirt	Lid	Lid Dia.	Max. Dia.	Clear Hole	Skirt I.D.	Overall	Lbs.
					A	B	Dia. C	D	Ht. E	
<b>8"</b>	A0717-188	Lay-in	Steel	Cast Iron	9.0"	9.9"	8.0"	8.4"	9.0"	11.2
	A0717-008	Lay-in	Poly	Cast Iron	9.0"	9.9"	8.0"	8.1"	13.0"	13.2
	A0717-108	Lay-in	Steel	Cast Iron	9.0"	9.9"	8.0"	8.4"	13.0"	12.6
<b>12"</b>	* <b>A0717-128</b>	Lay-in	Steel	Cast Iron	12.4"	13.8"	11.3"	12.0"	9.0"	21.8
	* <b>A0717-022</b>	Lay-in	Poly	Cast Iron	12.4"	13.8"	11.3"	12.0"	12.0"	18.0
	A0717-022B	Bolt-down	Poly	Cast Iron	12.4"	13.8"	9.4"	12.0"	12.0"	23.0
	* <b>A0717-122</b>	Lay-in	Steel	Cast Iron	12.4"	13.8"	11.3"	12.0"	12.0"	25.3
	A0717-122B	Bolt-down	Steel	Cast Iron	12.4"	13.8"	9.4"	12.0"	12.0"	28.8
	A0717-122FG	Lay-in, w/finger hole	Steel	Cast Iron	12.4"	13.8"	11.3"	12.0"	12.0"	26.0
	567177	Lid Only		Cast Iron	12.4"					10.0
<b>18"</b>	* <b>A0717-018</b>	Lay-in	Steel	Cast Iron	17.0"	17.8"	16.0"	16.6"	12.0"	51.0
	A0717-018A	Lay-in	Steel	Cast Iron	17.0"	17.8"	16.0"	16.6"	19.0"	58.1
	A0717-018B	Bolt-down	Steel	Cast Iron	17.0"	17.2"	14.1"	16.9"	12.0"	56.3
	567715X	Lid Only Lay-in (Old style)		Cast Iron	17.3"					26.5
	570893L	Lid Only Lay-in (> 05/14)		Cast Iron	17.0"					22.9
<b>24"</b>	A0717-024	Lay-in	Steel	3/8" Steel	23.6"	24.5"	21.6"	23.1"	13.0"	88.0
	A0717-024A	Lay-in	Steel	3/8" Steel	23.6"	24.5"	21.6"	23.0"	19.0"	98.0
	A0717-024CD	Cam Lock w/D-Seal	Steel	3/8" Steel	23.6"	24.5"	21.6"	23.0"	13.0"	90.0
	A0717-024CDA	Cam Lock w/D-Seal	Steel	3/8" Steel	23.6"	24.5"	21.6"	23.0"	19.0"	101.0
	A0717-124	Bolt-down	Steel	3/8" Steel	23.6"	24.5"	21.6"	23.0"	13.0"	90.0
	A0717-124B	Bolt-down	Steel	3/8" Steel	23.6"	24.5"	21.6"	23.0"	19.0"	100.0
<b>30"</b>	A0717-030	Lay-in	Steel	3/8" Steel	29.6"	30.5"	27.6"	29.0"	13.0"	125.0
	A0717-030B	Bolt-down	Steel	3/8" Steel	29.6"	30.5"	27.6"	29.0"	13.0"	127.0
	A0717-030CD	Cam Lock w/D-Seal	Steel	3/8" Steel	29.6"	30.5"	27.6"	29.0"	13.0"	128.0
<b>36"</b>	A0717-036	Lay-in	Steel	1/2" Steel	35.6"	36.5"	33.6"	35.0"	13.0"	206.0
	A0717-036B	Bolt-down	Steel	1/2" Steel	35.6"	36.5"	33.6"	35.0"	13.0"	208.0
	* <b>A0717-136</b>	Lay-in	Steel	3/8" Steel	35.6"	36.5"	33.6"	35.0"	13.0"	189.0
	A0717-136B	Bolt-down	Steel	3/8" Steel	35.6"	36.5"	33.6"	35.0"	13.0"	191.0
<b>37"</b>	A0717-037CD	Cam Lock w/D-Seal	Steel	3/8" Steel	37.0"	37.9"	35.0"	35.0"	13.0"	203.0
	A0717-037CDA	Cam Lock w/D-Seal	Steel	3/8" Steel	37.0"	37.9"	35.0"	35.0"	19.0"	218.0
<b>38"</b>	A0717-038	Lay-in	Steel	1/2" Steel	39.6"	40.5"	37.6"	39.0"	13.0"	270.0
	A0717-038A	Lay-in	Steel	1/2" Steel	39.6"	40.5"	37.6"	39.0"	19.0"	286.0
	A0717-038B	Bolt-down	Steel	1/2" Steel	39.6"	40.5"	37.6"	39.0"	13.0"	272.0
	* <b>A0717-038C</b>	Lay-in	Steel	3/8" Steel	39.6"	40.5"	37.6"	39.0"	13.0"	225.0
	A0717-038CB	Bolt-down	Steel	3/8" Steel	39.6"	40.5"	37.6"	39.0"	13.0"	227.0
<b>42"</b>	A0717-042A	Lay-in	Steel	1/2" Steel	44.1"	45.0"	42.1"	43.5"	13.0"	324.0
	A0717-042AB	Lay-in	Steel	1/2" Steel	44.1"	45.0"	42.1"	43.5"	19.0"	341.5
	A0717-042B	Bolt-down	Steel	1/2" Steel	44.1"	45.0"	42.1"	43.5"	13.0"	326.0
	A0717-042CD	Cam Lock w/D-Seal	Steel	3/8" Steel	44.1"	45.0"	42.1"	43.5"	13.0"	327.0
	A0717-042CDA	Cam Lock w/D-Seal	Steel	3/8" Steel	44.1"	45.0"	42.1"	43.5"	18.0"	344.5
	A0717-042D	Lay-in	Steel	3/8" Steel	44.1"	45.0"	42.1"	43.5"	13.0"	268.5
<b>48"</b>	A0717-048	Lay-in	Steel	1/2" Steel	47.1"	48.0"	45.1"	46.5"	13.0"	362.0
	A0717-048CD	Cam Lock w/D-Seal	Steel	3/8" Steel	47.1"	48.0"	45.1"	46.5"	13.0"	365.0
	A0717-148	Lay-in	Steel	3/8" Steel	47.1"	48.0"	45.1"	46.5"	13.0"	301.0

\*Most common variant

# Composite Manholes

## A0716 Composite Manholes

The Emco Wheaton A0716 Composite Manhole is designed with lightweight, slip-resistant composite manhole covers, using the latest manufacturing technology to ensure porosity-free molding, and compact, homogeneous distribution of reinforcing fiber. The covers also utilize a UV resistant treatment to protect against sun and weather damage.

Emco composite lids have a 36 month warranty. The ManholeTrak Warranty Tracking System is available on our website, [www.emcoretail.com](http://www.emcoretail.com).

- Meets AASHTO H20 Wheel Loading
- Slip resistant tread pattern
- Powder coated cast steel cam with o-ring
- Stainless steel fittings cam-lock fittings etched to show open and close directional arrows; field replaceable
- Stainless steel pry bar cleat
- Galvanized steel skirt (18")



### 39", 42" & 44" Models

- Domed top construction to shed water
- Stainless steel dual handle - spring-loaded and key-lift
- Hot rolled steel skirt
- Concrete anchors



Serial Number

Recessed spot  
face for fuel grade  
ID markers

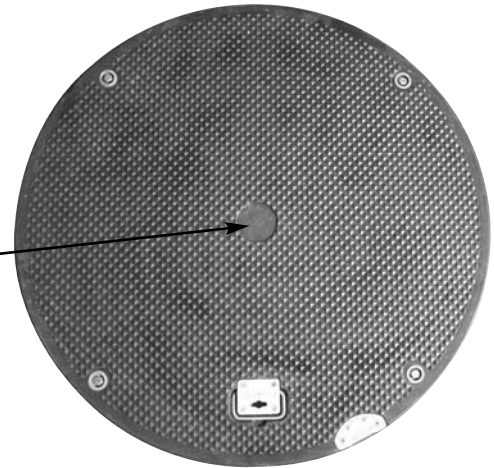

569427  
Euro Lift Handle

A0081-004CL  
Cam-Lock Wrench



## Wedding Cake Assemblies

Installs over containment sump

Part Number	Lid Dim. A	Clear Hole Dim. B	Height C	Height D
A0716-042CW	43.75"	41.63"	10.10"	21.25"
A0716-042CDW*	43.75"	41.63"	10.10"	21.25"
A0716-044CW	44.25"	41.69"	10.10"	21.25"
A0716-044CDW*	44.25"	41.69"	10.10"	21.25"

\*Includes water-tight D-Seal

Add "S" suffix for stainless steel rim and skirt

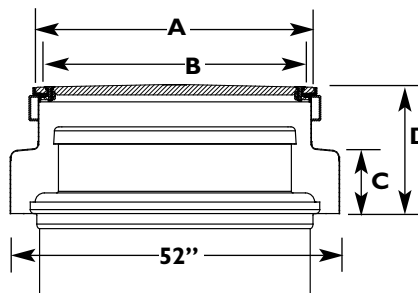

### All composite manholes are available with Type 304 stainless steel rim and skirt

Model Number	Style	Lid Dia. A	Overall Dia. B	Clear Hole C	Skirt ID D	Overall Ht. E	Lbs.
A0716-018SS	18" Lay-in	17.0"	17.9"	15.9"	16.1"	13.0"	32
A0716-039SS	39" Lay-in	39.5"	40.9"	37.8"	38.3"	13.0"	190
A0716-042SS	42" Lay-in	43.8"	45.2"	42.0"	42.5"	13.0"	221
A0716-044SS	44" Lay-in	44.3"	45.7"	42.5"	43.1"	13.0"	228

Cam-lock versions available - add a "C" to the end of the part number.

### Painted Lids - API Product Codes

Add to the end of the variant number:

- D Yellow ULSD
- R White Regular
- U Red Premium

Contact Customer Service at 800-234-4394 for additional colors

# Composite Manholes

## A0716 Composite Manholes

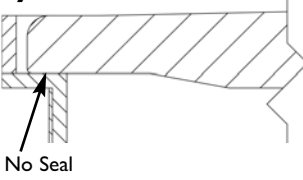
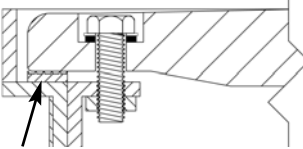
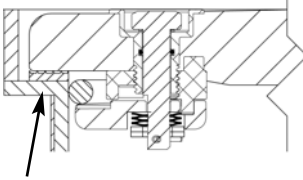
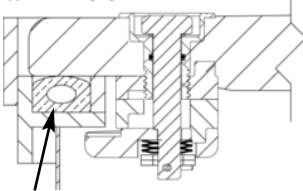
Seal Options	Model Number	Style	Lid Dia. A	Overall Dia. B	Clear Hole ID C	Skirt ID D	Overall Ht. E	Lbs.
<b>Lay-In</b>  <p>No Seal</p>	A0716-018	18" Lay-in	17.0"	17.8"	16.0"	17.0"	11.0"	37.3
	A0716-018L	18" Lid Only Lay-in	17.0"	--	--	--	--	12.9
	* <b>A0716-039</b>	39" Lay-in	39.5"	40.9"	37.8"	38.3"	10.0"	166
	A0716-039LID	39" Lid Only Lay-in	39.5"	--	--	--	--	120
	* <b>A0716-042</b>	42" Lay-in	43.8"	45.2"	42.0"	42.5"	10.0"	182
	A0716-042LID	42" Lid Only Lay-in	43.8"	--	--	--	--	143
	A0716-044	44" Lay-in	44.3"	45.7"	42.5"	43.1"	10.0"	188
A0716-044LID	44" Lid Only Lay-in	44.3"	--	--	--	--	137	
<b>Bolt-Down</b>  <p>Ribbed Seal, Water-resistant</p>	A0716-039B	39" Bolt-down	39.5"	40.9"	35.5"	38.3"	10.0"	170
	A0716-039BL	39" Lid Only Bolt-down	39.5"	--	--	--	--	120
	A0716-042B	42" Bolt-down	43.8"	45.2"	38.5"	42.5"	10.0"	174
	A0716-042BL	42" Lid Only Bolt-down	43.8"	--	--	--	--	143
	A0716-044B	44" Bolt-down	44.3"	45.7"	40.3"	43.1"	10.0"	199
	A0716-044BL	44" Lid Only Bolt-down	44.3"	--	--	--	--	137
<b>Cam-Lock</b>  <p>Ribbed Seal, Water-resistant</p>	A0716-018C	18" Cam Lock	17.0"	17.7"	15.1"	17.0"	11.0"	38.9
	A0716-018CW	18" Cam Lock White Lid	17.0"	17.7"	15.1"	17.0"	11.0"	38.9
	A0716-018CL	18" Lid Only Cam Lock	17.0"	--	--	--	--	14.6
	A0716-018CWL	18" Lid Only White Cam Lock	17.0"	--	--	--	--	14.6
	A0716-039C	39" Cam Lock	39.5"	40.9"	36.8"	38.3"	10.0"	175
	A0716-039CL	39" Lid Only Cam Lock	39.5"	--	--	--	--	123
	A0716-042C	42" Cam Lock	43.8"	45.2"	41.0"	42.5"	10.0"	211
	A0716-042CL	42" Lid Only Cam Lock	43.8"	--	--	--	--	163
	* <b>A0716-044C</b>	44" Cam Lock	44.3"	45.7"	41.5"	43.1"	10.0"	208
	A0716-044CL	44" Lid Only Cam Lock	44.3"	--	--	--	--	161
<b>Cam-Lock-D</b>  <p>D-Seal, Water-tight</p>	A0716-039CD	39" Cam Lock w/D-Seal	39.5"	40.9"	36.8"	38.3"	10.0"	175
	A0716-042CD	42" Cam Lock w/D-Seal	43.8"	45.2"	41.0"	42.5"	10.0"	211
	A0716-044CD	44" Cam Lock w/D-Seal	44.3"	--	--	--	--	161

\*Most common variant  
 Custom skirt heights available upon request

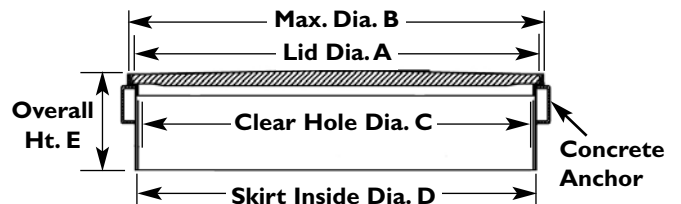

- 570897 Lid Seal, -018C
- 495157 Replacement Gasket, -039B, -039C, -042B, -042C
- 494988 Replacement Gasket, -044B, -044C

### Drop-In Replacement Lids for Competitors' Manholes:

Emco manufactures replacement lids in both composite and steel construction

Composite	3/8" Steel	OPW	Franklin	Flexing	Morrison	Environ
A0716-039E						WTM-3911
A0716-039LID	A0717-039LID	E00618	781-448-06			
A0716-039M	A0717-039M				318L-3812ACC	
A0716-042LID	A0717-042LID			14U-4210C		
A0716-044LID	A0717-044LID	E00626	781-445-06			
A0716-044E						WTM-4511, WTM-4521
A0716-044M	A0717-044M				318L-4412ACC	

<b>Composite Manholes</b>		<b>OPW</b>	<b>Franklin</b>	<b>Flexing</b>	<b>Morrison Bros.</b>
A0716-039	COMPOSITE LAY-IN 39X10	39CD-PL10	781-433-13	14U-3810	318L 3800AM
A0716-039B	COMPOSITE BOLT-DOWN 39X10	39CD-WT10	781-433-12	14URT-3810	418L 3800AM
A0716-039C	COMPOSITE CAM-LOCK 39X10	39CD-RL10			
A0716-039CL	COMPOSITE CAM-LOCK LID ONLY 39"	E00714			
A0716-039LID	COMPOSITE LAY-IN LID ONLY 39"	E00618	781-448-06	14U-3810C	
A0716-042	COMPOSITE LAY-IN 42X10			14U-4210	
A0716-042LID	COMPOSITE LAY-IN LID ONLY 42"			14U-4210C	
A0716-044	COMPOSITE LAY-IN 44X10	44CD-PL10	781-443-13		318L 4400AM
A0716-044B	COMPOSITE BOLT-DOWN 44X10	44CD-WT10	781-443-12		418L 4400AM
A0716-044C	COMPOSITE CAM-LOCK 44X10	44CD-RL10			
A0716-044CL	COMPOSITE CAM-LOCK LID ONLY 44"	E00712			
A0716-044LID	COMPOSITE LAY-IN LID ONLY 44"	E00626	781-445-06		

<b>Standard Manholes</b>		<b>OPW</b>	<b>Franklin</b>	<b>Pemco</b>	<b>Fairfield</b>
A0717-018	MANHOLE CI LID 18"X12" STEEL	104A-1800	781-418-08-STL	10618x10	180-12
A0717-018A	MANHOLE CI LID 18"X18" STEEL		781-418-18-STL		180-18
A0717-024	MANHOLE 3/8" STEEL LID 24"X10" STEEL	6110-2410	SR2409HD	10624X10	240 HD
A0717-030	MANHOLE 3/8" STEEL LID 30"X10" STEEL	6110-3010	SR3009HD	10630X10	300 HD-B
A0717-030B	MH 3/8" STEEL LID 30"X10" STEEL BD		SR3009WT	10730X10	300 WT
A0717-036	MANHOLE 1/2" STEEL LID 36"X10" STEEL		SR3609HD		
A0717-036B	MH 1/2" STEEL LID 36"X10" STEEL BD	6110-37WT	SR3609WT		
A0717-038	MANHOLE 1/2" STEEL LID 38"X10" STEEL		SR3809HD		
A0717-038B	MH 1/2" STEEL LID 38"X10" STEEL BD	6110-37WT	SR3809WT		
A0717-038C	MANHOLE 3/8" STEEL LID 38"X10" STEEL	6110-3710		10638X10	380HD
A0717-042A	MANHOLE 1/2" STEEL LID 42"X10" STEEL	6110-4200	SR4209HD		420HD
A0717-042D	MANHOLE 3/8" STEEL LID 42"X10" STEEL	6110-4200		10642X10	
A0717-048	MANHOLE 1/2" STEEL LID 48"X10" STEEL		SR4809HD	10748X10	480HD
A0717-108	MANHOLE CI LID 8"X12" STEEL			100C8X12	80-12
A0717-122	MANHOLE CI LID 12"X12" STEEL	104A-1200	781-212-12-CI	100C12X12	120-12
A0717-122BW	MANHOLE STL LID 12"X12" STEEL BD			10212X12	120WT
A0717-122FG	MANHOLE CI LID 12"X12" STEEL FINGER	104FG-1200			
A0717-124	MANHOLE STEEL LID 24"X10" STEEL BD	6110-24WT		10724X10	240WT
A0717-128	MANHOLE CI LID 12"X8" STEEL			100C12X8	120 8
A0717-136	MANHOLE 3/8" STEEL LID 36"X10" STEEL	6110-3710		10636x10	360 HD
A0717-136B	MH 3/8" STEEL LID 36"X10" STEEL BD			10736X10	360 WT
A0717-148	MANHOLE 3/8" STEEL LID 48"X10" STEEL		SR4809WT	10648X10	
A0717-188	MANHOLE CI LID 8"X9" STEEL		78120808	100C8X75	80 8

**Square Manholes and Vaults**

A0717-718	MANHOLE STEEL LID SQUARE 18"X9"				18S
A0717-724	MANHOLE STEEL LID SQUARE 24"X9"		SSQ2409	10524X24	24S
A0717-724A	MANHOLE STEEL LID SQUARE 24"X24"			10524X24X24	
A0717-724ABW	MANHOLE STEEL LID SQ 24"X24" BD WR			10524X24WT	
A0717-724V	MANHOLE LOCKING VAULT 24"X24"			104242424	
A0717-724VW	MANHOLE LOCKING VAULT 24"X24" WR			104242424WT	

**Monitoring Well Manholes**

		<b>Universal</b>	<b>Morrison Bros.</b>	<b>Pemco</b>	<b>Fairfield</b>
A0720-001	MONITOR WELL CAP, COLLAR & LOCK	1300-40	305XA-0100 AC		
A0721-018	MONITOR WELL 18"X12" STEEL		418XAP-1200 AM	106MW18X12	108-TMW-12
A0721-101	MONITOR WELL 12"X12" STEEL	65-1212-WC	418XAP-0400 AM	10312X12	120-MW-12
A0721-106	MONITOR WELL 6"X8" STEEL			1035X6	
A0721-106A	MONITOR WELL 6"X10" STEEL			1035X12	
A0721-108	MONITOR WELL 8"X12" STEEL	65-8012-WC	418XAP-0900 AM	1038X12	80-MW-12
A0721-118	MONITOR WELL 18"X18" STEEL		418XAP-1300 AM		180-TMW-18
A0721-119	MONITOR WELL 12"X19" STEEL			10312X18	
A0721-128	MONITOR WELL 12"X8" POLY			10312X8	
A0721-188	MONITOR WELL 8"X9" STEEL	65-8075-WC	418XAP-0850 AM	1038X75	80-MW-8
A0721-188L	MONITOR WELL 8"X9" STEEL LAY-IN	60MW-8075		100MW8X75	
A0721-208	MONITOR WELL 8"X12" HD STEEL		418XAW-0700 AM		