

Overfill Prevention Valve

A1100 Guardian Overfill Prevention Valve

The Emco Wheaton A1100 is a two stage overfill prevention valve for use in both dual point and coaxial drop tubes, gravity feed systems. Easily installs in a new or existing drop tube assembly for economical compliance with EPA regulations. Internal float design to eliminate any chance of the floats getting caught on tank walls or the riser pipe as well as to prevent float damage during installation. Stick diverter and automatic spring loaded poppet retract from the flow path when the valve is not in operation, allowing for stick gauging at any tank level. Compatible with all standard fuels. Special variants are available for most bulk chemical applications.



- **Drain Bleed Valve** for hose drainage, reduces unnecessary delays. Spring loaded and includes soft seat for positive seal
- **Protective Retainer** over floats for protection during installation, shipping and operation
- **Cast-in Dip Stick Diverters** permit stick gauging at any tank level without damage to internal parts
- **Vertical Slide Float Design** for protection during installation
- **Auto Relatch** prevents premature shut-off
- **Integrated Body Design** suitable for both dual point and coaxial drop tubes - one valve for all applications
- **Shock Relief Valve** incorporated to reduce line shock
- **Viton® O-Rings** at base of valve seals drop tube to valve to protect against leakage

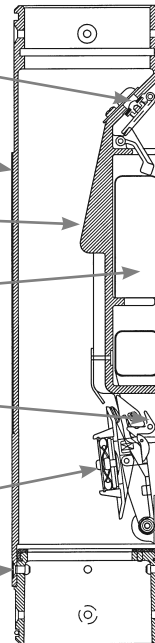

Material

Body: Aluminum
 Floats: HDPE
 Seals: Viton®

Viton® is a registered trademark of The Chemours Company

Specifications

Weight: 5.2 lbs.
 Diameter: 3.76"
 Length: 18.0"

Approvals

CARB Approval	99-8
ULC	UL 2583 Listed (MH21164)
Florida DEP	EQ-414

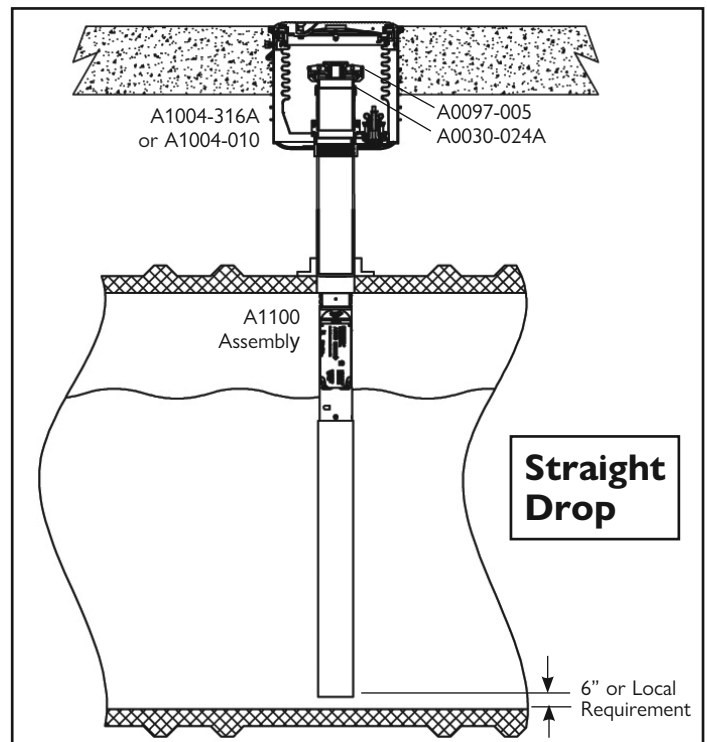

Overflow Prevention Valve

A1100 Guardian Overflow Prevention Systems

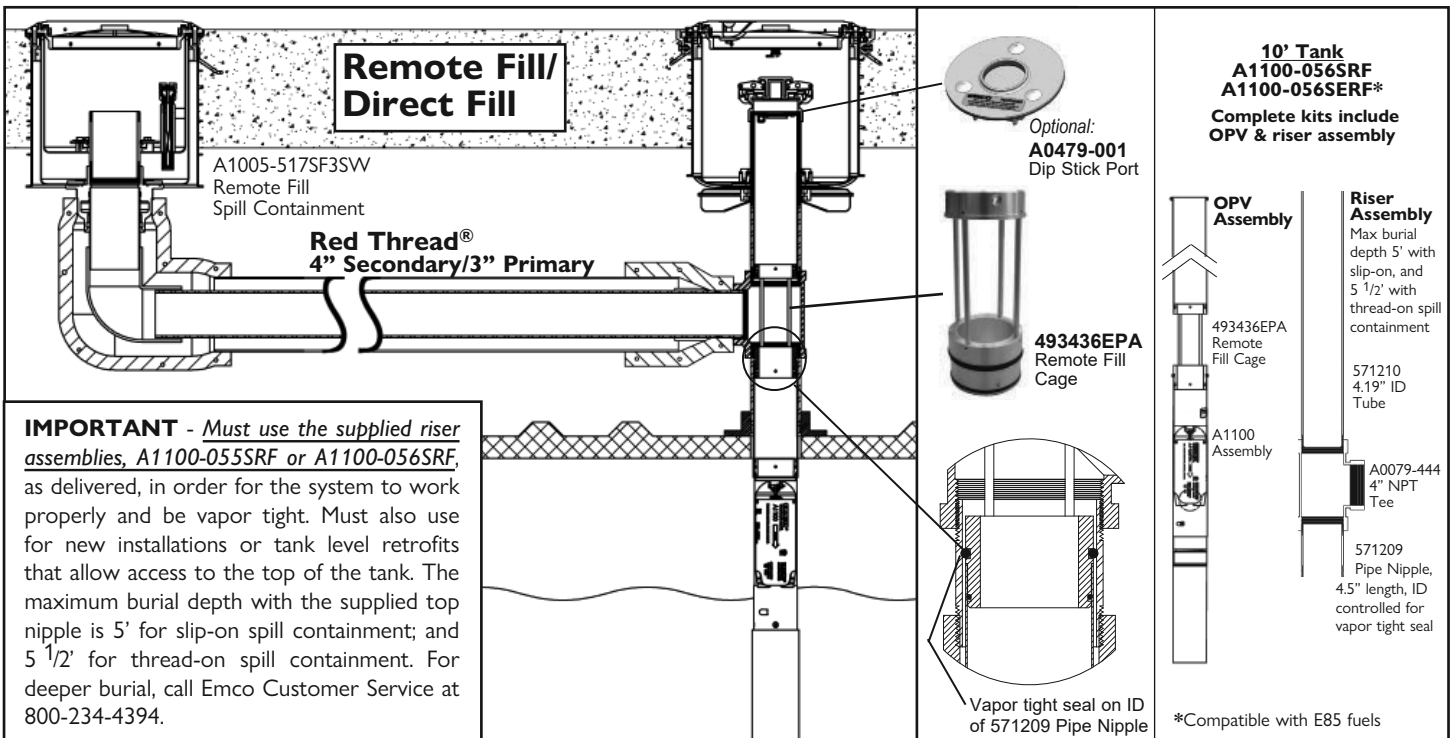
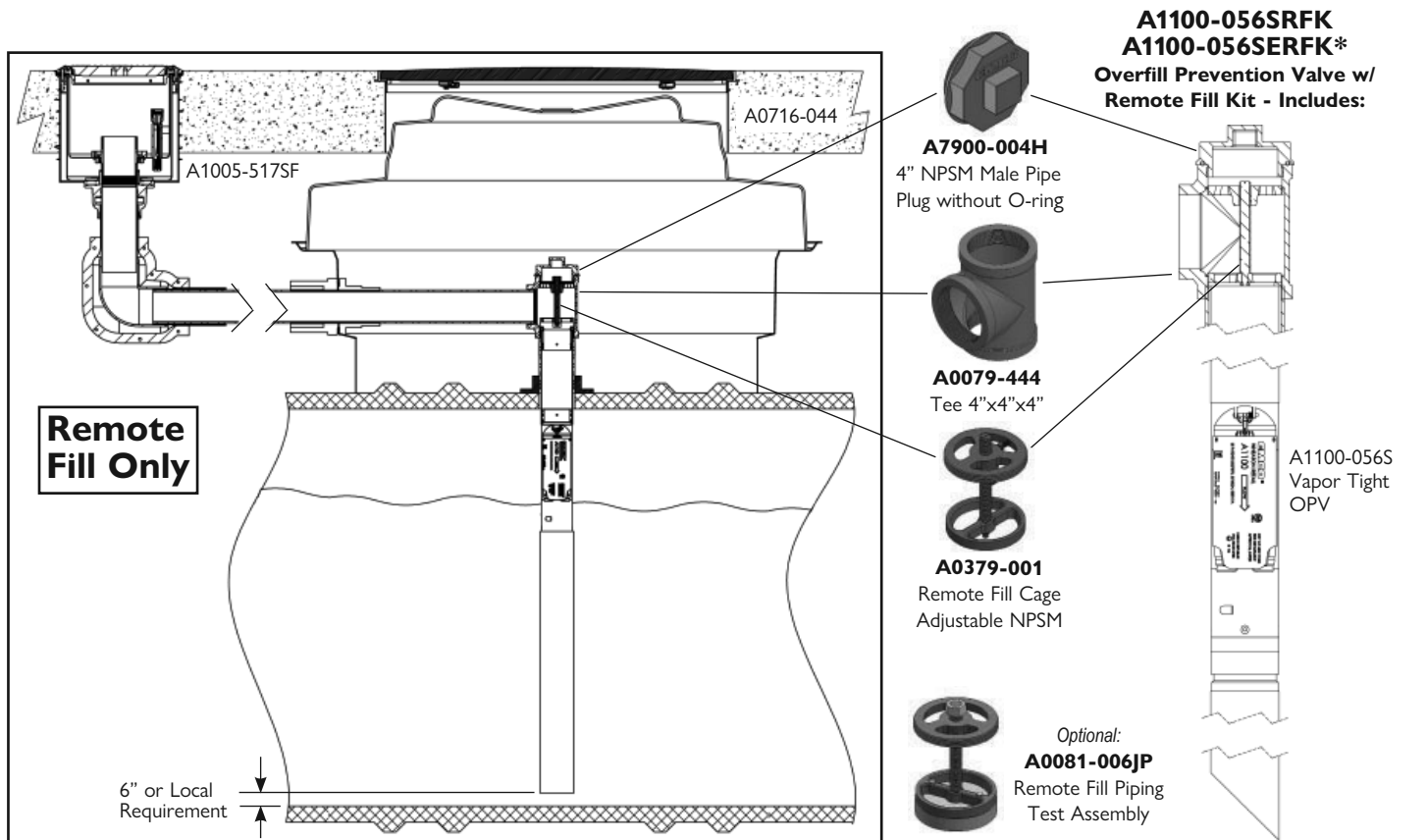

Overfill Prevention Valve

A1100 Standard Dual Point Overfill Prevention Systems

All Emco Wheaton assemblies are factory welded. The bottom tube screws together with the valve/top tube assembly.

All assemblies are vapor tight and meet EPA 40 CFR Part 63 requirements. No epoxy needed. All standard A1100 variants are acceptable for use with up to E25 ethanol blend gasoline and B20 biodiesel blends. A higher percentage of ethanol or biodiesel requires the use of the "E" variant. All OPVs are available with anodized top tubes (champagne color for easy identification) to prevent corrosion build-up between the drop tube and the riser pipe.

Model No.	Description
493192	Valve to Tube Rivet Assembly Kit
493436	Remote Fill Kit
493734S	Riser Collar Kit
493734SXL	Riser Collar Kit Extended 10.7"
493734SXXL	Riser Collar Kit Extended 20.7"
496360	Upright Functional Test Tool Kit
566675	Drill Fixture, Steel
571814	Drill Fixture, Remote Fill Assemblies
572719	Drill Fixture, Plastic
A0379-001	Remote Fill Cage Adjustable NPSM
A0379-101	Remote Fill Cage Adjustable BSPP



**566675, 572719
Drill Fixture**
Aligns holes for attaching support collar



**571814
Drill Fixture**
For remote fill applications

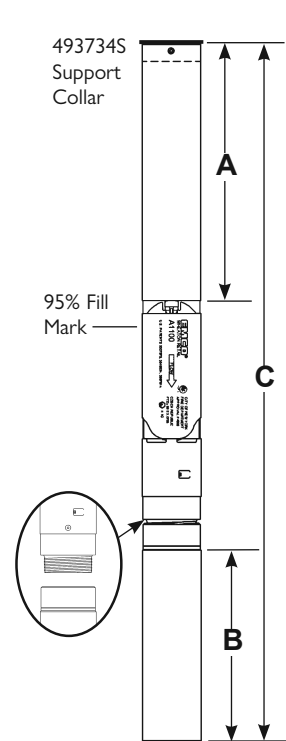

Model No.	Description	Lengths			Max Burial Depth	Tank Dia.	Lbs.
		Top "A"	Bottom "B"	Overall "C"			
A1100-010	Valve Only	N/A	N/A	N/A	N/A	N/A	5.2
A1100-011	Valve Only Remote Fill	N/A	N/A	N/A	N/A	N/A	5.0
A1100-054S	Remote Fill Export	47"	99"	161"	N/A	N/A	28.5
A1100-054SC	Remote Fill w/Cage BSPT	47"	99"	161"	N/A	N/A	27.9
A1100-054SCN	Remote Fill w/Cage NPT	47"	99"	161"	N/A	N/A	25.0
A1100-056SERF	Remote Fill Kit, Buried E85	82"	94"	199"	4.0'***	10.0'	66.5
A1100-056SRF	Remote Fill Kit, Buried	82"	94"	199"	4.0'***	10.0'	66.5
A1100-056SERFK	Remote Fill Kit, Sump E85	82"	94"	191"	--	10.0'	40.7
A1100-056SRFK	Remote Fill Kit, Sump	82"	94"	191"	--	10.0'	40.7
A1100-053S	Dual Pt Screw Together	58"	49"	122"	5.0'	6.5'	22.1
* A1100EVR-055	Dual Pt Screw Together	70"	82"	167"	6.0'	8.0'	25.2
** A1100EVR-055CF	Dual Pt Screw Together	70"	82"	167"	6.0'	8.0'	25.2
* A1100EVR-056	Dual Pt Screw Together	82"	94"	191"	7.0'	10.0'	27.2
** A1100EVR-056CF	Dual Pt Screw Together	82"	94"	191"	7.0'	10.0'	27.2
A1100EVR-057	Dual Pt Screw Together	82"	120"	217"	6.8'	12.0'	30.3
A1100EVR-057E	Dual Pt Screw Together E85	82"	120"	217"	6.8'	12.0'	30.5
* A1100EVR-058	Dual Pt Screw Together	120"	120"	255"	10.0'	12.0'	31.0
** A1100EVR-058CF	Dual Pt Screw Together	120"	120"	255"	10.0'	12.0'	31.0

The A1100 Overfill Prevention Valve is not recommended for tanks under 6.5' in diameter.

Maximum burial depth assumes 95% shut-off and 6" clearance between top of drop tube and inside bottom of containment manhole lid.

* Phase I EVR E.O. VR-105

** Anodized top tube

*** **SRF variants are designed for precise burial depth of 46"-54"; tank top access required.** For additional applications and installation instructions, call Customer Service at 800-234-4394.

OPV systems can be ordered as a package with a fill cap and fill adapter. Contact Customer Service for ordering information. Custom lengths available.



Overfill Prevention Valve

Replacement Parts

Dual Point

Top and bottom tube assemblies can be purchased separately:

Top tube assemblies include upper tube and valve assembly.

Bottom tube assemblies include lower tube and bushing assembly.

Model No.	Description	Length
A1100EVR-055ST	Top Tube Assembly	85"
A1100EVR-056ST	Top Tube Assembly	97"
A1100EVR-057ST	Top Tube Assembly	97"
A1100EVR-058ST	Top Tube Assembly	135"
494406A	Bottom Tube Assembly	83"
494441A	Bottom Tube Assembly	95"
494341A	Bottom Tube Assembly	121"



Top Tube Assembly



Bottom Tube Assembly

Extended Collar Kits

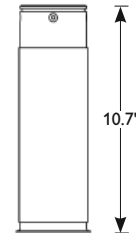

493734SXL
Increases tube length as much as 8" after standard collar is removed

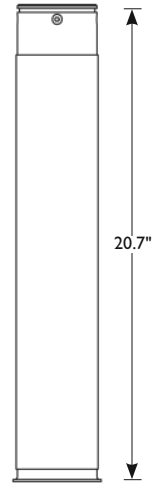

493734SXXL
Increases tube length as much as 18" after standard collar is removed

Coaxial

Top and bottom tube assemblies can be purchased separately:

Top tube assemblies include upper tube and valve assembly.

Bottom tube assemblies include lower tube and bushing assembly.

Model No.	Description	Length
A1100-065ST	Top Tube Assembly	80"
A1100-066ST	Top Tube Assembly	80"
A1100-067ST	Top Tube Assembly	80"
A1100-085ST	Top Tube Assembly	80"
A1100-086ST	Top Tube Assembly	80"
A1100-087ST	Top Tube Assembly	80"
494406A	Bottom Tube Assembly	83"
494441A	Bottom Tube Assembly	95"
494341A	Bottom Tube Assembly	121"



Top Tube Assembly



Bottom Tube Assembly